

SEC A-A

SEC B-B

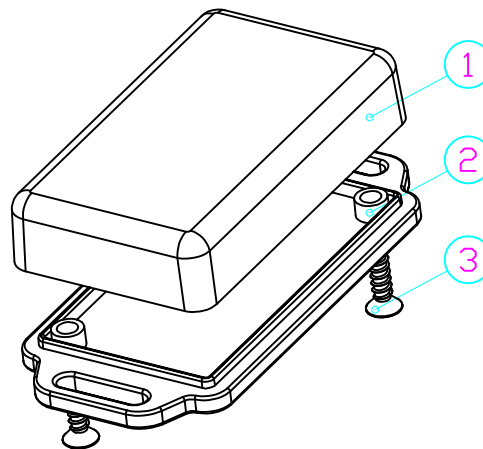

3	螺丝M2	钢	2	KB3*12	
2	下壳	ABS	1	50029-C1	
1	上壳	ABS	1	50029-B1	
序号	零件名称	材料	数量	配件编号	备注
制图	审核	批准	产品名称	壁挂式仪表盒	视图
Drawing	Auditing	Confirm	Product Name		Project View
			产品型号	BMW 50029	图纸比例
			Product Type		Drawing Scale
					1:1 (MM)



北京巴哈尔科技有限公司  
BEIJING BAHAR TECHNOLOGY CO., LTD

中国·深圳  
TEL: +86-755-33262000  
FAX: +86-755-33262020