

### ■ Features

- Low noise and high gain.  
NF = 1.1 dB Typ.,  $G_a = 11$  dB Typ. @ $V_{CE} = 10$  V,  $I_c = 7$  mA,  $f = 1.0$  GHz
- High power gain.  
MAG = 13 dB Typ. @ $V_{CE} = 10$  V,  $I_c = 20$  mA,  $f = 1.0$  GHz

### ■ hFE Classification

Marking	R25
Rank	S
hFE	120 ~ 220

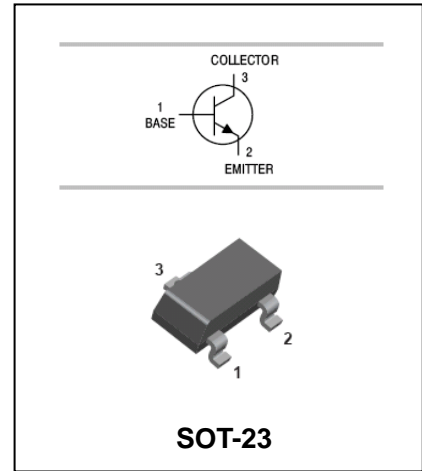

### ■ Absolute Maximum Ratings $T_a = 25^\circ\text{C}$

Parameter	Symbol	Rating	Unit
Collector to base voltage	$V_{CBO}$	20	V
Collector to emitter voltage	$V_{CEO}$	12	V
Emitter to base voltage	$V_{EBO}$	3.0	V
Collector current (DC)	$I_c$	100	mA
Total power dissipation	$P_{tot}$	200	mW
Junction temperature	$T_j$	150	$^\circ\text{C}$
Storage temperature range	$T_{stg}$	-65 to +150	$^\circ\text{C}$

### ■ Electrical Characteristics $T_a = 25^\circ\text{C}$

Parameter	Symbol	Testconditions	Min	Typ	Max	Unit
Collector cutoff current	$I_{CBO}$	$V_{CB} = 10$ V, $I_E = 0$ mA			1.0	$\mu\text{A}$
Emitter cutoff current	$I_{EBO}$	$V_{EB} = 1.0$ V, $I_c = 0$ mA			1.0	$\mu\text{A}$
DC current gain *	hFE	$V_{CE} = 10$ V, $I_c = 20$ mA	50	120	250	
Insertion power gain	$ S_{21e} ^2$	$V_{CE} = 10$ V, $I_c = 20$ mA, $f = 1$ GHz		11.5		dB
Noise figure	NF	$V_{CE} = 10$ V, $I_c = 7$ mA, $f = 1$ GHz		1.1	2.0	dB
Reverse transfer capacitance	$C_{re}$	$V_{CB} = 10$ V, $I_E = 0$ mA, $f = 1$ MHz		0.55	1.0	pF
Transition frequency	$f_r$	$V_{CE} = 10$ V, $I_c = 20$ mA		7		GHz

\*. Pulse measurement:  $PW \leq 350 \mu\text{s}$ , Duty Cycle  $\leq 2\%$ .

### TYPICAL CHARACTERISTICS (T<sub>A</sub> = 25 °C)

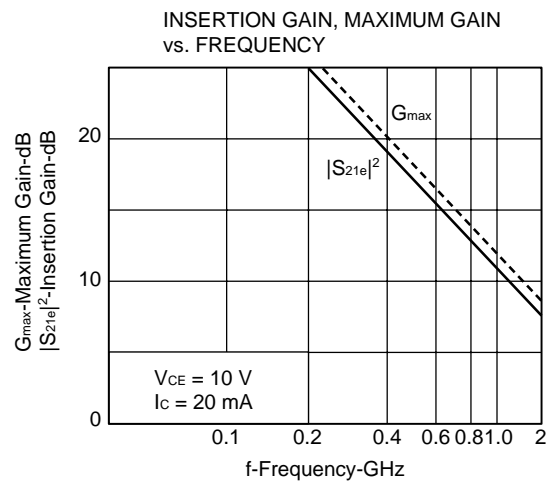
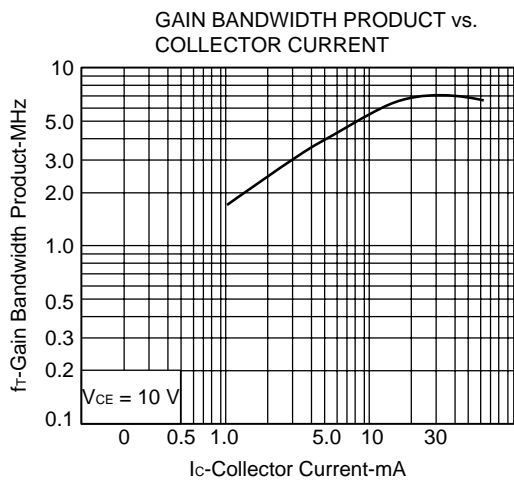
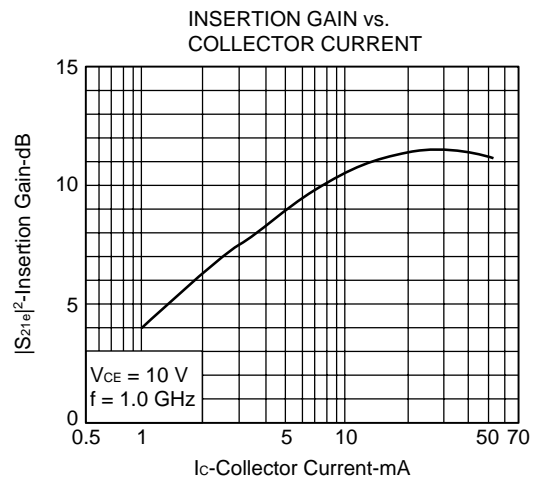
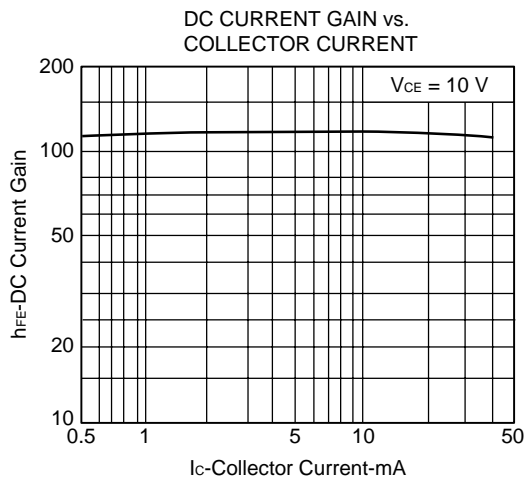
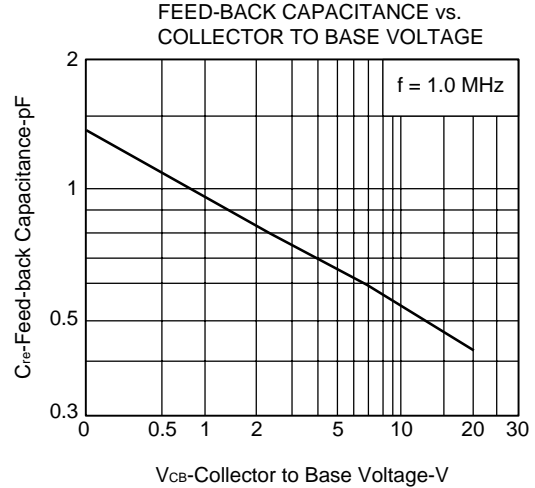
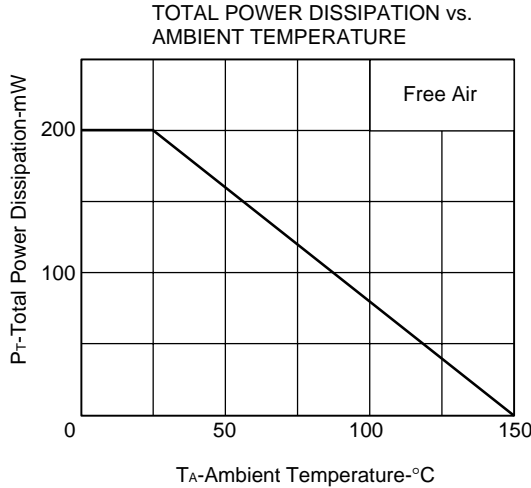

### PACKAGE OUTLINE

Plastic surface mounted package

SOT-23

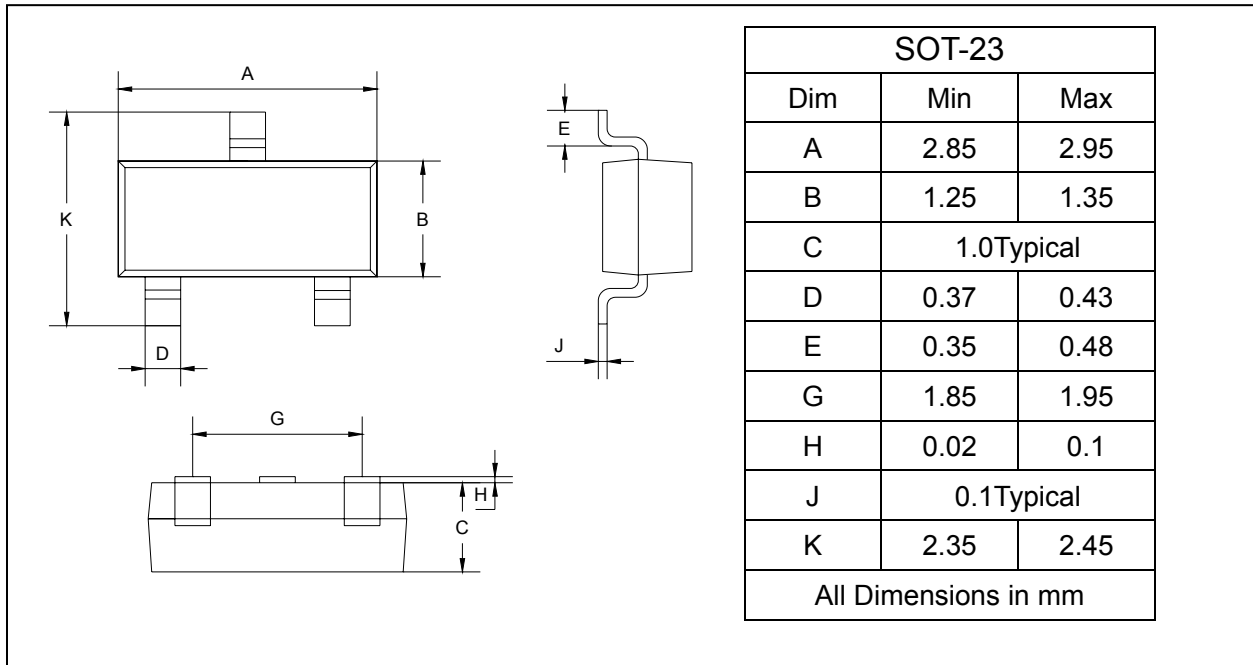

### SOLDERING FOOTPRINT

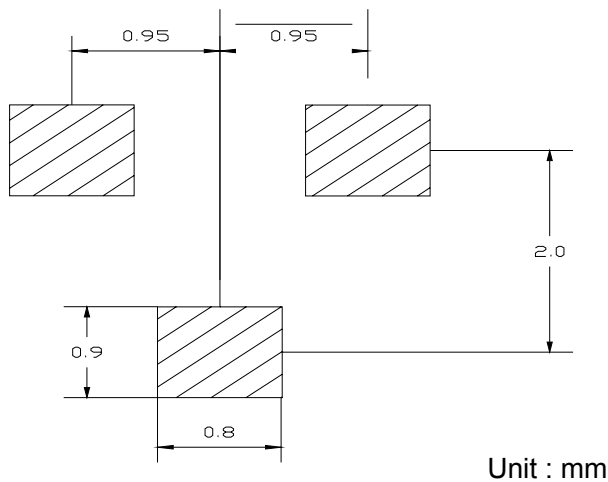

### PACKAGE INFORMATION

Device	Package	Shipping
2SC3356	SOT-23	3000/Tape&Reel